

UDK: 633.15

Originalni naučni rad
Original scientific paper

SPECTRAL ANALYSIS FOR MONITORING CROP GROWTH USING TRACTOR MOUNTED SPECTRORADIOMETER AND HAND HELD GREENSEEKER IN COTTON

Kothawale Anil Gautam^{1*}, Vishal Bector¹, Varinderpal Singh², Manjeet Singh¹

*Punjab Agricultural University,
Department of Farm Machinery and Power Engineering, Punjab, India
Punjab Agricultural University,
Department of Soil Science, Ludhiana, Punjab, India*

Abstract: Remotely sensed spectral vegetation indices are widely used and have benefited numerous disciplines interested in the assessment of biomass, water use, plant stress, plant health and crop production. Tractor mounted Spectroradiometer and hand held GreenSeeker were used to capture the spectral signatures of cotton crop canopy and to calculate *NDVI* which indicated the temporal changes in crop canopy, nutritional status and phenological conditions in cotton. The structural mechanism for mounting spectroradiometer on the tractor was prepared with various options of adjustments to use spectroradiometer infield. Spectral signatures of crop were measured using tractor mounted spectroradiometer and GreenSeeker at different growth stages in two cultivars of cotton. The relations between *NDVI* spectroradiometer (R_{650} and R_{770}) and plant N, plant biomass and plant height at $p=0.05$ level of significance were found as quadratic, exponential and linear with maximum value of coefficient of determination (R^2) of 0.806, 0.807 and 0.801 respectively. However, the relations between *NDVI* (GreenSeeker) and plant N, plant biomass and plant height at $p=0.05$ level of significance were found as quadratic, quadratic and linear with maximum R^2 value of 0.828, 0.817 and 0.839 respectively. A close relationship between *NDVI* Spectro-radiometer (R_{650} and R_{770}) and *NDVI* (GreenSeeker) was observed with R^2 value of 0.833 at $p=0.05$ level of significance. The study suggested that *NDVI* at (R_{650} and R_{770}) using spectroradiometer can be used as a reliable tool for fertilizer N management in cotton.

Keywords: *cotton, spectroradiometer, wavelength, greenseeker, NDVI*

* Corresponding author. E-mail: anilkothawale37@gmail.com

INTRODUCTION

Cotton (*Gossypium spp.*) a member of Malvaceae family is a major fibre producing crop with high commercial value and global importance. It is grown in temperate and tropical region of more than 70 countries. In terms of botanical status and quality of the fibre, the Indian cotton cultivation is most diverse in the world. All the four cultivated species and their interspecific hybrids are grown only in India. Nitrogen (*N*) is the most important limiting factor in cotton production. Inadequate *N* supply during the vegetative period will slow or stop leaf development. For optimal *N* management, it is important to understand the relationship between the morphological and physiological changes as crop grows. Individual plant species can vary tremendously in physiological behaviour over their life cycle and their nutrient requirements will change during various stages of growth [2].

To optimize the profitability with a reduced environmental impact, the precision agriculture concept was initiated for crop specific management. Precision farming is focused on nitrogen application rate and timing for high yield, crop quality and environmental pollution control [4]. Precision agriculture technology mainly using more information for higher production [6]. Precision agriculture mainly involves ‘the right dose at right place at the right time. The main components of precision agriculture are positioning system, remote sensing, variable rate technology, crop and soil sensing and analysis, yield mapping and information. Hence, agricultural equipments are moving towards the high automation with the help of electronics and information technology.

All objects on the earth produces electromagnetic radiations (*EMR*) is depend upon the physical properties. These are known as ‘spectral signatures’ of particular body Remotely sensed spectral vegetation indices are widely used and have benefited numerous disciplines interested in the assessment of biomass, water use, plant stress, plant health and crop production. Hyperspectral remote sensing capability to detect characteristic differences of cotton canopy under different nitrogen application rates and different growing stage was studied [7]. Hyper spectral reflectance from cotton crop canopy was used to find indices like Difference Vegetation Index (*DVI*), Ratio Vegetation Index (*RVI*), Normalized Difference Vegetation Index (*NDVI*), and Renormalized Difference Vegetation Index (*RDVI*) [8].

Spectroradiometer captures the reflectance of cotton crop canopy at different wavelength and helps in finding the vegetative indices *DVI*, *RVI*, *NDVI* and *RDVI* relations with plant *N*, plant height, above ground biomass at various growth stages of crop. It would help growers make field management decisions such as fertilizer application, irrigation scheduling, and plant growth regulator applications for maximum yield and quality.

Now days, hand held portable spectroradiometers are being used to collect the hyperspectral data of cotton crop canopy. Manually operated spectroradiometer having problem of non-uniform height, shaking of hand and spectral probe is not uniformly perpendicular to crop canopy. These problems cause the disturbed spectral data. To avoid these problems there is a requirement of development structural mechanism for mounting a spectroradiometer on tractor.

The present study has been planned with the following objectives:

1. To develop structural mechanism for mounting of spectroradiometer on the tractor to capture hyper spectral data of cotton crop canopy.

2. To develop relationships between *NDVI* calculated using tractor mounted Spectroradiometer and hand held GreenSeeker with different growth parameters.
3. To study relationship between *NDVI* calculated by using Spectroradiometer and GrenSeeker.

MATERIAL AND METHODS

The field experiment was conducted during crop season *kharif* 2014 at the experimental farm, Department of Soil Sciences, Punjab Agricultural University, Ludhiana, Punjab, India at 30°56' N latitude and 75°52' E longitude with a mean height of 247 meter above the mean sea level. The field experiment was designed in split plot design with two cultivars (*ANKUR 3028 BG- II* and *RCH 650*) in main plots and seven N fertilizer applications (0, 30, 60, 75, 90, 120 and 150 kgN·ha⁻¹) treatments in sub plots with three replications. Total 42 plots of size 9 x 2.7 (24.3 m²) were sown at row to row spacing of 60 cm and plant to plant spacing of 67.5 cm.

Development and fabrication of frame to mount spectroradiometer on tractor. The computer aided design of structural mechanism for mounting spectroradiometer on the tractor was prepared in three – dimensional solid modeling software tool called *CATIA*. The frame was fabricated using 60 × 60 mm iron square hollow bar, iron plate, iron rod as dimension given in (Fig. 1). The fabricated frame having various options of adjustments to use spectroradiometer infield during various crop growth stages was mounted on the high clearance tractor (Fig. 2).

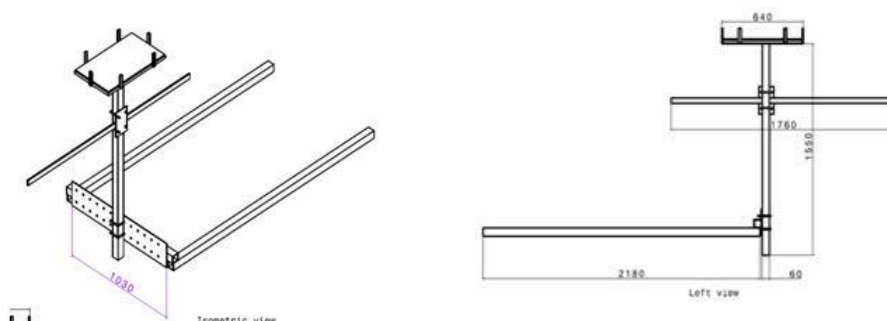

Figure 1. Structural mechanism for mounting spectroradiometer on the tractor (all dimension in mm)

Collection of Spectral Signatures. Spectral properties of cotton crop were measured using tractor mounted Spectroradiometer and handheld GreenSeeker at 10 days interval starting from squaring stage of 41 days after sowing (*DAS*) to boll opening stage of 101 *DAS*.

Tractor Mounted Spectroradiometer. A 512 – channel ASD Fieldspec® Pro 2000 Spectroradiometer (Analytical Spectral Device Inc., Boulder, CO, USA) with range 350 – 2500 nm was mounted on developed panel mounted on high clearance tractor (Figure. 2). A Spectralon white reference panel was used to optimize the instrument to 100 %

reflectance at all wavebands prior to canopy reflectance measurement. Canopy spectra from cotton were measured at 11:00 – 14:00 hours under cloudless and windless weather conditions. Reflectance measurement was made about 1 m above canopy throughout the growing season. Sensor facing the crop and oriented normal to plant using 25° field of view (*FOV*) was used to get 5 spectral reflectance measurements from each plot. During the reflectance measurement tractor was kept in steady state.



Figure 2. Capturing of spectral signatures of cotton crop using tractor mounted spectroradiometer and hand held GreenSeeker

GreenSeeker optical sensor. The GreenSeekerTM hand held optical sensor unit Model 505 was used to measure NDVI from the crop canopy using light emitting diodes with reflectance in red region (656 nm) and *NIR* (774 nm). Before taking the readings, iPAQ was inserted in the powered cradle and battery was charged properly. Then shoulder strap was put around the body and sensor angle was such adjusted that it was kept parallel to sensing area at a height of about 1.0 m above the canopy (Fig. 2). The trigger of GreenSeeker optical sensor was pressed continuously while moving in the middle of the crop rows and trigger was released after completing one plot. A photo diode detector within the sensor measured the magnitude of the light reflected off the target and *NDVI* was computed. The data from the sensor was transmitted serially to HPiPAQ Personal Digital Assistant, which was later exported to a desktop computer for analysis.

Collection of samples and analysis. One cotton plant was collected at different growth stages. The samples were oven dried at 60°C to record the dry weight of leaves and plant biomass. Dried samples were grounded in grinder for estimating N content. The stover samples were collected at harvesting and were also dried at 60°C for N content analysis. Nitrogen concentration in the leaf, plant and stover were determined by Kjeldhal method [1].

Selection of wavelength for NDVI from tractor mounted spectroradiometer. Spectroradiometer was used to measure the reflectance of five randomly selected plants in each plot during various growth stages of cotton crop. Average reflectance of five plants recorded at each wavelength from 350 nm to 2500 nm. Normalized Difference Vegetative Index (*NDVI*) was selected as indicator of total biomass and greenness of leaves and determined with the following equation:

$$NDVI = (NIR_{ref} - RED_{ref}) / (NIR_{ref} + RED_{ref}) \quad (1)$$

where:

NIR ref [-] - reflectance in the near infrared region,

RED ref [-] - reflectance of in the red region.

From that average value of reflectance *NDVI* was calculated for four selected combinations of wavelengths using one wavelength in *NIR* (770 nm) which is sensitive to *N* application (Brosonet *al* 2005) with three selected wavelengths in red region (600 nm, 650 nm and 700 nm). However fourth *NDVI* was calculated by using average reflectance of wavelength in *NIR* region (749 nm-950 nm) and red region (620-650 nm).

Statistical Analysis. An analysis of variance (*ANOVA*) was performed to test *N* effects on plant *N*, plant biomass, plant height, *NDVI* (R_{600} and R_{770}), *NDVI* (R_{650} and R_{770}), *NDVI* (R_{700} and R_{770}) *NDVI* (R_{red} and R_{NIR}) and *NDVI* (GreenSeeker). Mean separation was determined using LSD at level of significance of $P = 0.05$. Analyses were performed using software Crop stat. *NDVI* (R_{600} and R_{770}), *NDVI* (R_{650} and R_{770}), *NDVI* (R_{700} and R_{770}) and *NDVI* (R_{red} and R_{NIR}) was related to plant *N*, plant biomass and plant height. The software used for all curve fittings was TableCurveTM 2D windows version 4.06 (SPSS Inc., Chicago, IL).

RESULTS AND DISCUSSION

Relations between plant height, plant *N*, plant biomass and *NDVI* using tractor mounted spectroradiometer and hand held GreenSeeker

The reflectance around 550 or 585 nm in green region was closely correlated with cotton leaf *N* content [5]. *NDVI* calculated from reflectance at 2 m above the cotton canopy was positively correlated with biomass and lint yield [3]. The relation between *NDVI* (Spectroradiometer) and plant height, plant *N*, plant biomass and at $p=0.05$ level of significance was linear, quadratic and exponential with maximum R^2 value of 0.801, 0.807 and 0.807 respectively (Tab. 1, Fig. 3). The relation between *NDVI* (GreenSeeker) plant height, plant *N* and plant biomass at $p=0.05$ level of significance was linear, quadratic and quadratic with maximum R^2 value of 0.839, 0.817 and 0.817 respectively (Tab. 2, Fig. 4).

Table 1. Relation between plant *N*, plant biomass, plant height and *NDVI* (Spectroradiometer)

Parameter	Relation	Equation	R^2
Plant height	Linear	$y = 293.41x - 137.22$	0.801
Plant <i>N</i>	Quadratic	$y = 39.757x^2 + 52.229x - 14.356$	0.806
Plant biomass	Exponential	$y = 0.0031e^{13.49x}$	0.807

Table 2. Relation between plant *N*, plant biomass, plant height and *NDVI* (GreenSeeker)

Parameter	Relation	Equation	R^2
Plant height	Linear	$y = 175.33x - 36.076$	0.839
Plant <i>N</i>	Quadratic	$y = -11.129x^2 - 10.969x + 0.0758$	0.828
Plant biomass	Quadratic	$y = 1249.8x^2 - 913.91x + 160.09$	0.817

Relation between *NDVI* calculated using tractor mounted spectroradiometer and hand held GreenSeeker

Overall relations of *NDVI* (GreenSeeker) with *NDVI* (R_{600} and R_{770}), *NDVI* (R_{650} and R_{770}), *NDVI* (R_{700} and R_{770}), *NDVI* (R_{Red} and R_{NIR}) across the cultivars at different growth stages were established (Figs. 5 to 8).

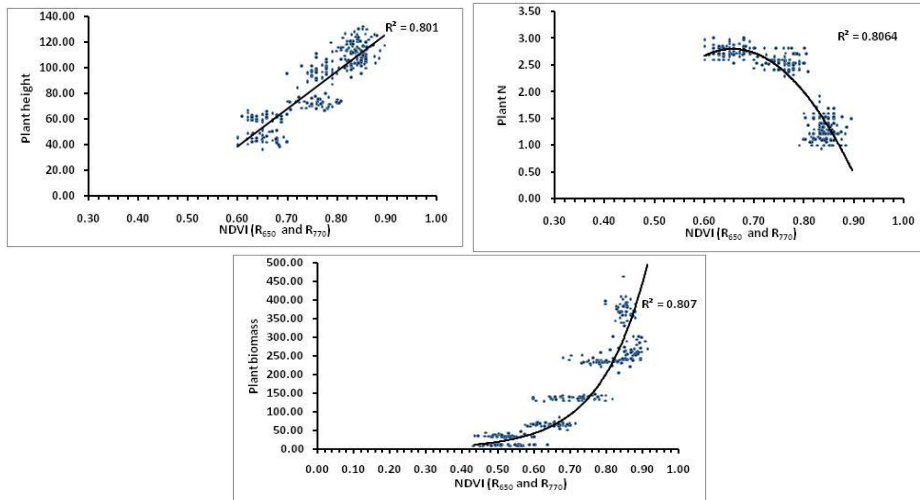

Figure 3. Relation between plant height, plant N, plant biomass and *NDVI* (R_{650} and R_{770}) calculated using tractor mounted Spectroradiometer

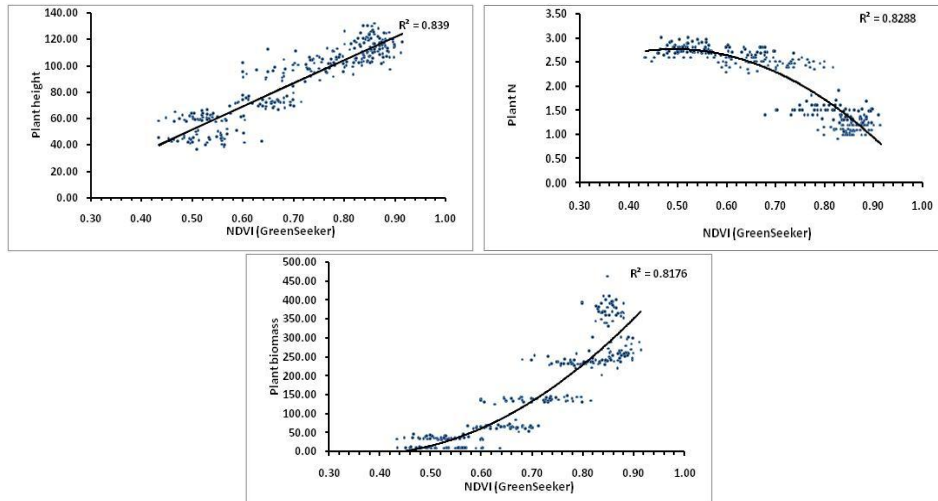

Figure 4. Relation between plant N, plant biomass, plant height and *NDVI* calculated using hand held GreenSeeker

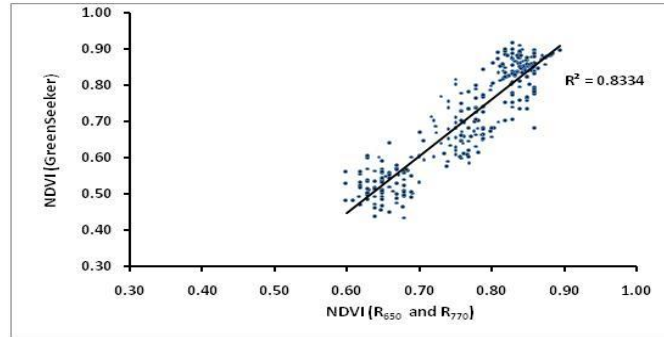

Figure 5. NDVI (R_{600} and R_{770}) calculated using tractor mounted spectroradiometer and NDVI calculated using hand held GreenSeeker

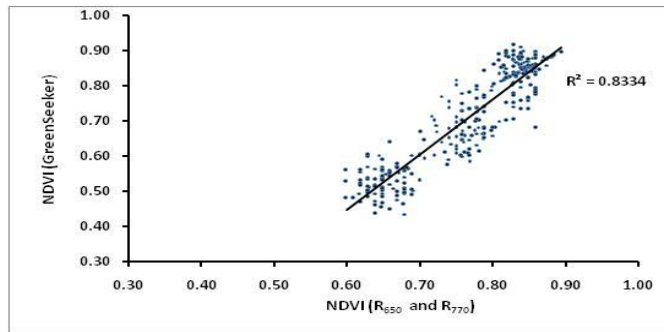

Figure 6. NDVI (R_{650} and R_{770}) calculated using tractor mounted spectroradiometer and NDVI calculated using hand held GreenSeeker

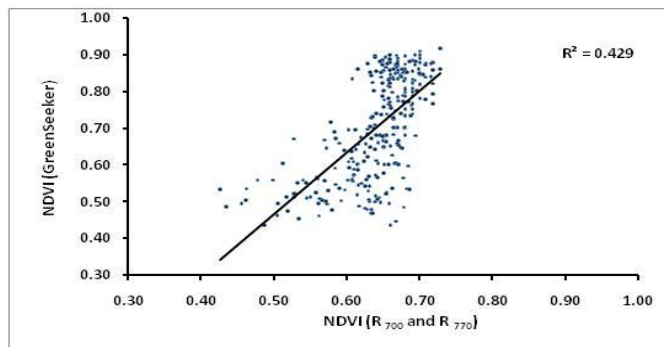

Figure 7. NDVI (R_{700} and R_{770}) calculated using tractor mounted spectroradiometer and NDVI calculated using GreenSeeker

A close relationship between NDVI (GreenSeeker) and NDVI Spectroradiometer (R_{650} and R_{770}) was observed with coefficient of determination (R^2) of 0.833 at $p=0.05$ level of significance at different growth stage of cotton (Fig. 6). However, NDVI (GreenSeeker) and NDVI Spectroradiometer (R_{600} and R_{770}), NDVI (R_{700} and R_{770}), NDVI

(R_{Red} and R_{NIR}) at $p=0.05$ level of significance at different growth stage of cotton were not closely related (Fig. 5, 7 and 8). The data suggested that $NDVI$ (R_{650} and R_{770}) can be used as a reliable substitute of $NDVI$ (GreenSeeker) to guide in season fertilizer N topdressings in cotton.

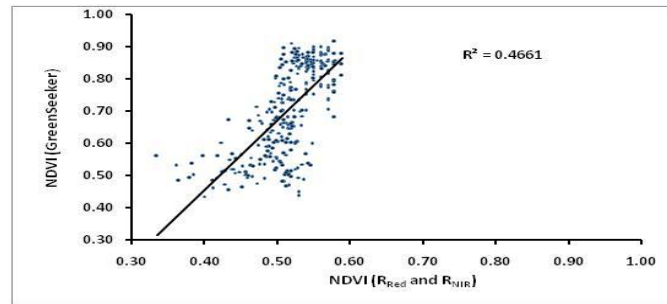

Figure 8. $NDVI$ (R_{Red} and R_{NIR}) calculated using tractor mounted spectroradiometer and $NDVI$ calculated using GreenSeeker

CONCLUSIONS

Structural frame was developed for mounting spectroradiometer on tractor for capturing the spectral signatures of cotton crop canopy with uniform height of 1m above the crop canopy.

- $NDVI$ calculated using reflectance in red region at 650nm and reflectance in NIR region at 770 nm had quadratic, exponential and linear relation with plant N content, plant biomass and plant height respectively.
- $NDVI$ calculated using hand held GreenSeeker had linear, quadratic and quadratic relation with plant height, plant biomass and plant N.
- Linear relation was observed between $NDVI$ calculated using reflectance in red region at 650nm and in NIR region at 770 nm by spectroradiometer and $NDVI$ (GreenSeeker).
- It was found that $NDVI$ at (R_{650} and R_{770}) using spectroradiometer can be used as a reliable tool for fertilizer N management in cotton.

BIBLIOGRAPHY

- [1] Bremner, J.M., Mulvaney, C.S. 1982. *Total nitrogen*. In: Page A.L., Miller R.H., Keeney D.R. (eds) *Methods of soil analysis: Part 2. Chemical and microbiological properties*. pp 595-624.
- [2] Jeffery, C.S., Bronson, F.K., Norton, E.R., Mikkelsen, R. 2011. Nitrogen Utilization by Western U.S. Cotton. *Better Crops* (95), 21-23.
- [3] Li, H., Lascano, R.J., Barnes, E.M., Booker, J., Wilson, L.T., Bronson, K.F., Segarra, E. 2001. Multispectral Reflectance of Cotton Related to Plant Growth, Soil Water and Texture, and Site Elevation. *Agronomy Journal* (93),1327-37.

- [4] Pattey, E., Strachan, I.B., Boisvert, J.B., Desjardins, R.L., McLaughlin, N. 2001. Effects of Nitrogen Application Rate and Weather on Corn using Micrometeorological and Hyperspectral Reflectance Measurements. *Agriculture and Forest Meteorology* (108), 85– 99
- [5] Read, J.L., Tarpley, J.M., McKinion, Reddy, K.R. 2002. Narrow-Waveband Reflectance Ratios for Remote Estimation of Nitrogen Status in Cotton. *Journal of Environmental Quality* (31), 1442-52.
- [6] Schneider, M., Wanger, P. 2007. Prerequisites For The Adoption Of New Technologies – The Example Of Precision Agriculture. *Scientific Journal Agricultural Engineering* (XXXII), 9-14.
- [7] Zhao, D., Jianlong, L.I., Jiagua, Q.I. 2004. Hyperspectral Characteristic Analysis of a Developing Cotton Canopy under Different Nitrogen Treatments. *Journal of Agronomy* (24), 463-71.
- [8] Zhao, D., Reddy, R.K, KakaniGopal, V., Reddy, V.R. 2005. Nitrogen Deficiency Effects on Plant Growth, Leaf Photosynthesis and Hyperspectral Reflectance Properties of Sorghum. *European Journal of Agronomy* (22), 391-403.

**SPEKTRALNA ANALIZA ZA PRAĆENJE PORASTA USEVA
POMOĆU TRAKTORSKOG SPEKTORADIOMETRA
I RUČNOG SENZORA STANJA USEVA U PAMUKU**

Kothawale Anil Gautam¹, Vishal Bector¹, Varinderpal Singh², Manjeet Singh¹.

*Poljoprivredni univerzitet Punjab,
Institut za poljoprivredne i pogonske mašine, Punjab, India
Poljoprivredni univerzitet Punjab,
Institut za zemljište, Ludhiana, Punjab, India*

Sažetak: Daljinska spektralna detekcija vegetacije se široko koristi u mnogim oblastima u kojima je potrebna procena biomase, korišćenja vode, stresa kod biljaka, zdravlja biljaka i biljne proizvodnje. Traktorski spektrometar i ručni sensor stanja useva su korišćeni za snimanje spektralnih potpisa useva pamuka i proračun *NDVI* indeksa, što je pokazalo povremene promene biljnog pokrivača, nutritivno stanje i fenološke uslove u kojima se pamuk nalazi. Konstrukcija za postavljanje pektoradiometra na traktor je izvedena sa različitim mogućnostima za podešavanje upotrebe uređaja na parceli. Spektralni potpisi useva mereni su spektrometrom postavljenim na traktoru i ručnim senzorom stanja useva u različitim fazama porasta kod dve sorte pamuka. Odnosi između *NDVI* indeksa spektrometra (R_{650} i R_{770}) i biljnog azota, biomase biljaka i visine biljaka na nivou značajnosti $p=0.05$ bili su kvadratni, eksponencijalni i linearni, sa maksimalnim vrednostima koeficijenta determinacije (R^2) od 0.806, 0.807 i 0.801, redom. Pored ovoga, odnosi između *NDVI* (Green-Seeker) i biljnog azota, biomase biljaka i visine biljaka na nivou značajnosti $p=0.05$ bili su kvadratni, kvadratni i linearni, sa maksimalnom vrednošću R^2 od 0.828, 0.817 i 0.839, redom. Značajna zavisnost *NDVI* spektrometra (R_{650} i R_{770}) i *NDVI* (GreenSeeker) bila je utvrđena sa vrednošću R^2 od 0.833 na nivou značajnosti $p=0.05$. Istraživanje je

pokazalo da *NDVI* kod (R_{650} i R_{770}) upotrebom spektrometra može da se upotrebi kao pouzdano sredstvo za upravljanje đubrenjem azotom kod pamuka.

Ključne reči: pamuk, spektrometar, talasna dužina, ručni senzor stanja useva, *NDVI* indeks

Prijavljen: 09.10.2015.
Submitted:
Ispravljen: 22.06.2016.
Revised:
Prihvaćen: 25.06.2016.
Accepted: